

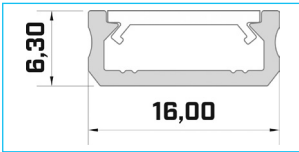





PERFIL D

Tipo	PERFIL DE SUPERFICIE
Medidas (mm)	2020
Tira de LED	hasta 12mm
Aplicaciones	Cocinas y tiendas





ACABADOS

 BLANCO (Lacado) ST1D2RAL9016	 NEGRO (Anonizado) ST1D2C35	 INOX (Anonizado) ST1D2C32	 PLATA (Anonizado) ST1D2C0
---	--	---	--

TAPAS

	Blanco Basic	Negro Basic	Inox Basic	Gris Basic	Blanco High	Negro High	Inox High	Gris High
con agujero								
sin agujero								
	ST1ZASWD	ST1ZASBD	ST1ZASID	ST1ZASGD	ST1ZASWAH	ST1ZASBAH	ST1ZASIAH	ST1ZASGAH

	Clip de montaje con una cobertura básica						
	Blanca	Blanca High	Negra	Negra High	Transparente	Transp. High	
	ST1UCHWA	ST1CHWAH	ST1UCHBA	ST1UCHBAH	ST1UCHTA	ST1UCHTAH	Colgante

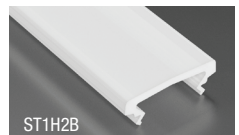
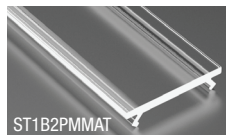
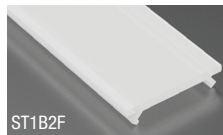
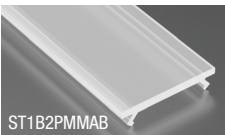

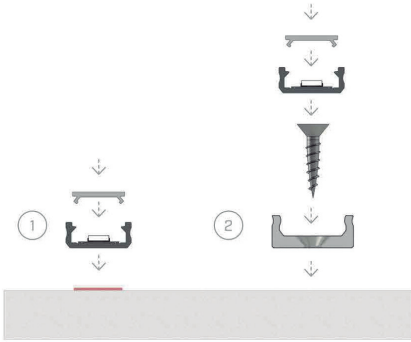

Instrucciones de instalación del perfil D con cobertura básica: (1) cinta de doble cara (2) un pasador de ensamblado y tornillo MINI

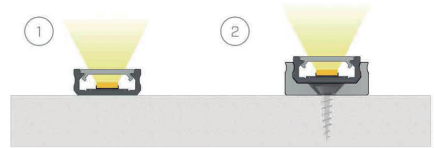

Resultado final del montaje del perfil D con cobertura básica: (1) cinta de doble cara (2) un pasador de ensamblado y tornillo MINI

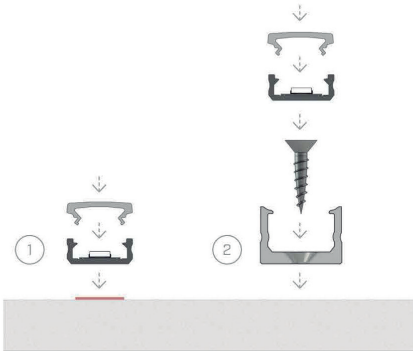

Instrucciones de instalación del perfil D con una cobertura High; (1) cinta de doble cara (2) un pasador de ensamblado y tornillo MINI

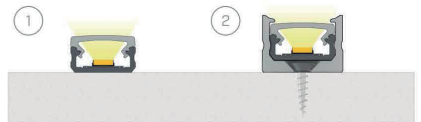

Resultado final de la instalación del perfil D con una cobertura High; (1) cinta de doble cara (2) un pasador de ensamblado y tornillo MINI

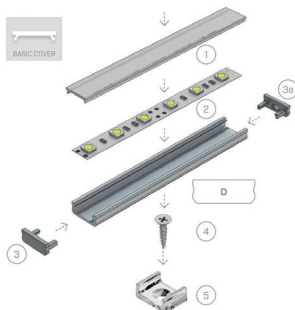

Esquema de montaje del Perfil D Basic
 (1) una cobertura básica,
 (2) una tira de LED,
 (3) una tapa de extremo con agujero,
 (3a) una tapa de extremo sin agujero,
 (4) un tornillo de montaje,
 (5) una placa de montaje MINI para el perfil



Esquema de montaje del Perfil D High
 (1) una cobertura High,
 (2) una tira de diodos electroluminiscentes,
 (3) una tapa con agujero,
 (3a) una tapa de extremo sin agujero,
 (4) un tornillo de montaje,
 (5) una placa de montaje