

## PERFIL LARGO

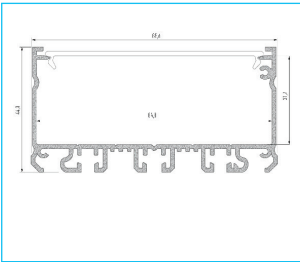

Tipo	<b>PERFIL SUPERFICIE</b>
Medidas (mm)	<b>1000, 2020, 3000</b>
Tira de LED	<b>6x12 mm</b>











### TAPAS

	Blanco	Gris
con agujero	 ST12043110	 ST12051510
sin agujero	 ST12043111	 ST12051511

### ACABADOS

 <b>BLANCO (Lacado)</b> ST10028110	 <b>PLATA (Anonizado)</b> ST10028410
--	---

### ACCESORIOS

 ST10024410	 ST10025410	 ST10026410	 ST10027410	 ST14504601
 ST14303202	 ST14303001	 ST14303801	 ST14303601	 ST14201001

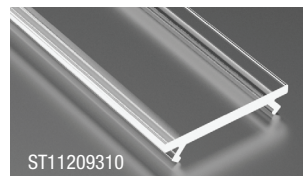
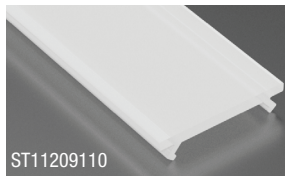
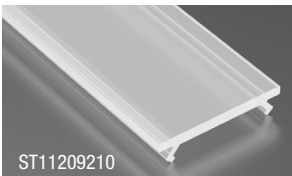

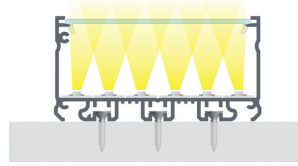
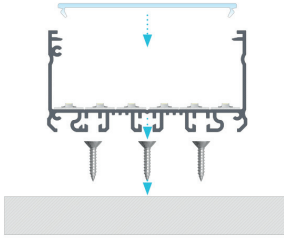

Instrucciones de instalación de perfil LARGO con difusor SUPER WIDE usando tornillos de montaje.

El resultado final de montaje de perfil LARGO con difusor SUPER WIDE usando los tornillos de montaje.

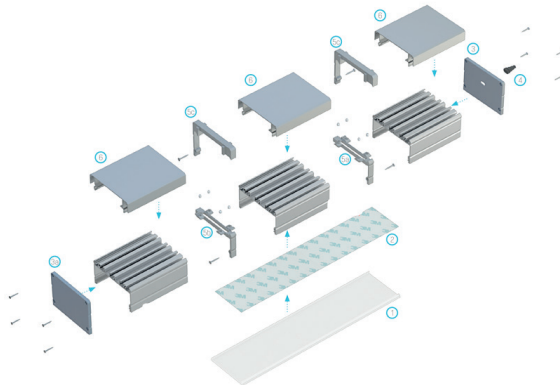

El esquite ade montaje de elementos de sistema de iluminación usando perfil LARGO (1) difusor SUPER WIDE, (2) tiras LED, (3) tapón TALIA + M1 con agujero, (3a) tapón TALIA + M1 sin agujero, (4) cierre, (5a) conector derecho LARGO (5b) conector izquierdo LARGO, (5c) conector LARGO M1, (6) perfil de montaje LARGO M1.



## PERFIL LARGO M1

Tipo

**PERFIL MONTAJE SUPERFICIE**

Medidas (mm)

**1000, 2020, 3000**

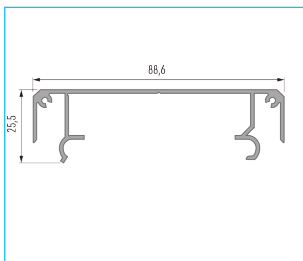

### ACABADOS



### TAPAS

	Blanco	Gris	Largo+M1 B	Largo+M1 G
con agujero	 ST12044110	 ST12044510	 ST12045110	 ST12045510
sin agujero	 ST12044111	 ST12044511	 ST12045111	 ST12045511

### ACCESORIOS

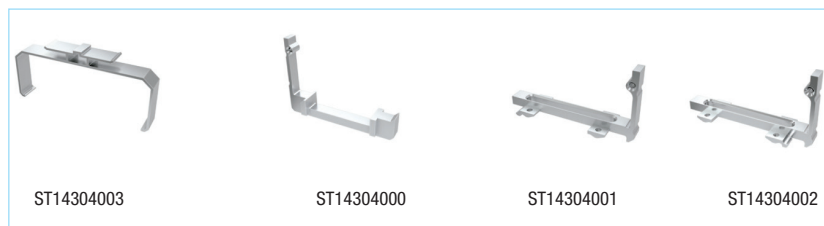

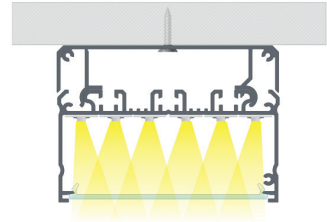
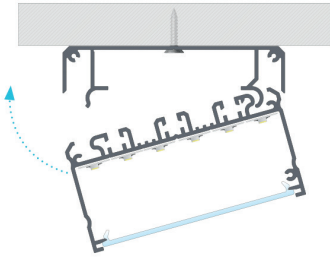

El principio de montaje de sistema de perfil LARGO con difusor SUPER WIDE usando el perfil de montaje LARGO M1.

El resultado final de montaje de perfil LARGO con difusor SUPER WIDE usando el perfil de montaje LARGO M1.

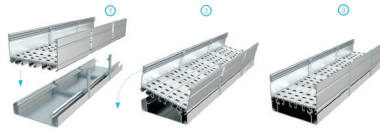

El principio de montaje de sistema de perfil LARGO usando conectores de perfil y el perfil de montaje M1.

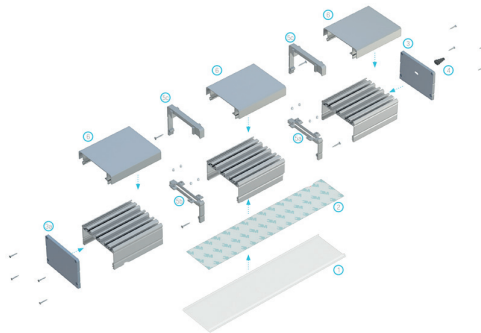

El esquema de montaje de elementos de sistema de iluminación usando perfil LARGO (1) difusor SUPER WIDE, (2) tiras LED, (3) tapón TALIA + M1 con agujero, (3a) tapón TALIA + M1 sin agujero, (4) cierre, (5a) conector derecho LARGO (5b) conector izquierdo LARGO, (5c) conector LARGO M1, (6) perfil de montaje LARGO M1.

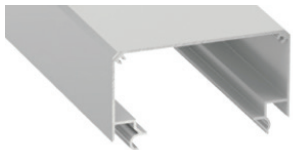

## PERFIL LARGO M2

Tipo

**PERFIL MONTAJE SUPERFICIE**

Medidas (mm)

**1000, 2020, 3000**

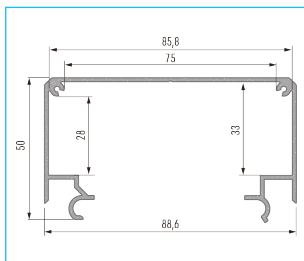

### ACABADOS



### TAPAS



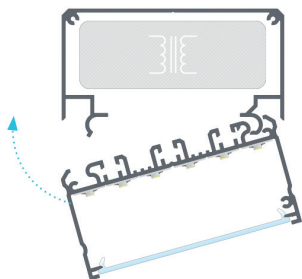

El principio de montaje de perfil LARGO con difusor SUPER WIDE usando el perfil de montaje LARGO M2 con la finalidad de tener fuente de energía.

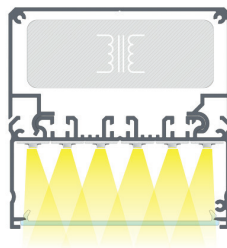

El resultado final de montaje de perfil LARGO con difusor SUPER WIDE usando perfil LARGO M2 con finalidad de tener fuente de energía.

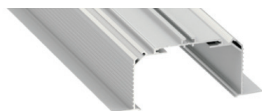

## PERFIL LARGO M3

Tipo

**PERFIL MONTAJE SUPERFICIE**

Medidas (mm)

**1000, 2020, 3000**

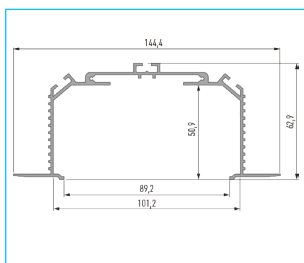

### TAPAS

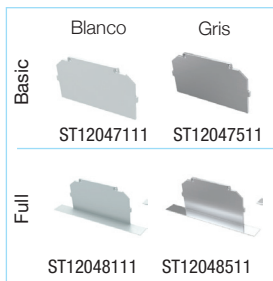

### ACABADOS



### ACCESORIOS



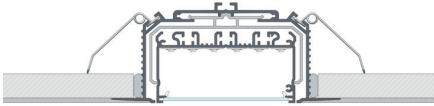

El resultado final de montaje de perfil LARGO con difusor SUPER WIDE y perfil de montaje LARGO con muelle de montaje.

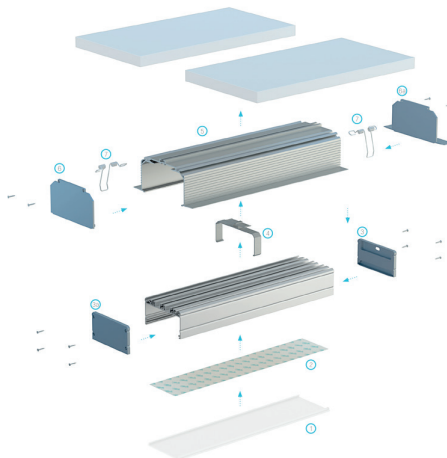

El esquema de montaje de sistema de iluminación de techo usando perfil LARGO, (1) difusor SUPER WIDE, (2) tiras LED, (3) tapón LARGO con agujero, (3a) tapón largo sin agujero, (4) conector entre perfiles LARGO, (5) perfil de montaje LARGO M3, (6) tapón LARGO M3 con acabado completo, (7) muelle de montaje.



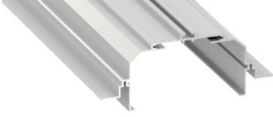

## PERFIL LARGO M4

Tipo  
Medidas (mm)

**PERFIL MONTAJE SUPERFICIE**  
**1000, 2020, 3000**

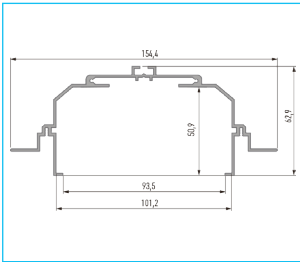

### ACABADOS



### TAPAS

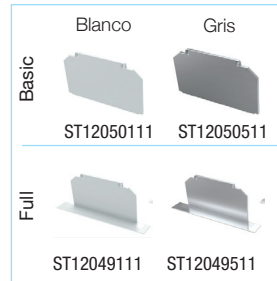

### ACCESORIOS



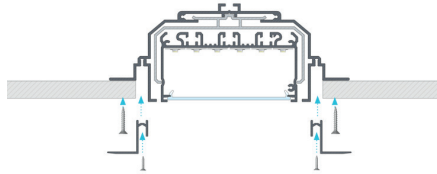

El principio de montaje de perfil LARGO con difusor SUPER WIDE usando el perfil de montaje LARGO M4, conector entre perfiles LARGO y perfil auxiliar ROSET.

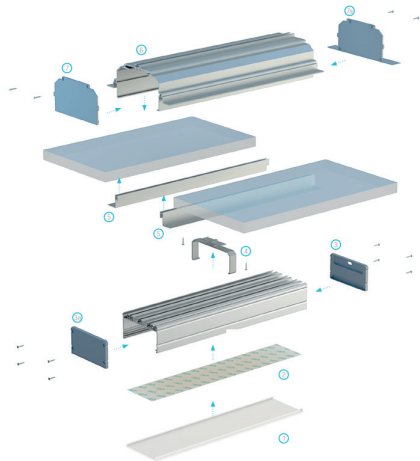

El esquite ade montaje de elementos de sistema de iluminación usando perfil LARGO (1) difusor SUPER WIDE, (2) tiras LED, (3) tapón LARGO con agujero, (3a) tapón LARGO sin agujero, (4) conector entre perfiles LARGO, (5) perfil auxiliar ROSET, (6) perfil de montaje LARGO M4, (7) tapón LARGO M4 con acabado recto, (7a) tapón LARGO M4 con acabado completo.